

DAU SURFACE

D93146

| | |
|----------|--|
| PROJECT | |
| TYPE | |
| NOTES | |
| QUANTITY | |
| DATE | |

GENERAL

Series: Dau
 Brand: Milan
 Division: Design
 Mounting Type: Surface
 Mounting Location: Wall

PHYSICAL

Shape: Cube
 Length (mm): 110
 Length (in): 4 ⁵/₁₆
 Height (mm): 110
 Height (in): 4 ⁵/₁₆
 Extension (mm): 101
 Extension (in): 4.0
 Weight (kg): 0.91
 Weight (lbs): 2
 Fixture Finish: SST
 Fixture Material: Metal

ELECTRICAL

Number of Lamps: 1
 Lamp Type: LED
 Max. Wattage Per Lamp (W): 4
 Dimming: Electronic Low Voltage Dimming
 Input Voltage (V): 120

LED

Number of LEDs: 1
 Color Temperature (°K): 2700 / 2900
 Nominal Lumen (lm): 300
 CRI: >80 CRI

OPTICAL

RATINGS AND CERTIFICATIONS

Certified By: CSA Certified to UL and CSA Standards
 IP rating: IP20

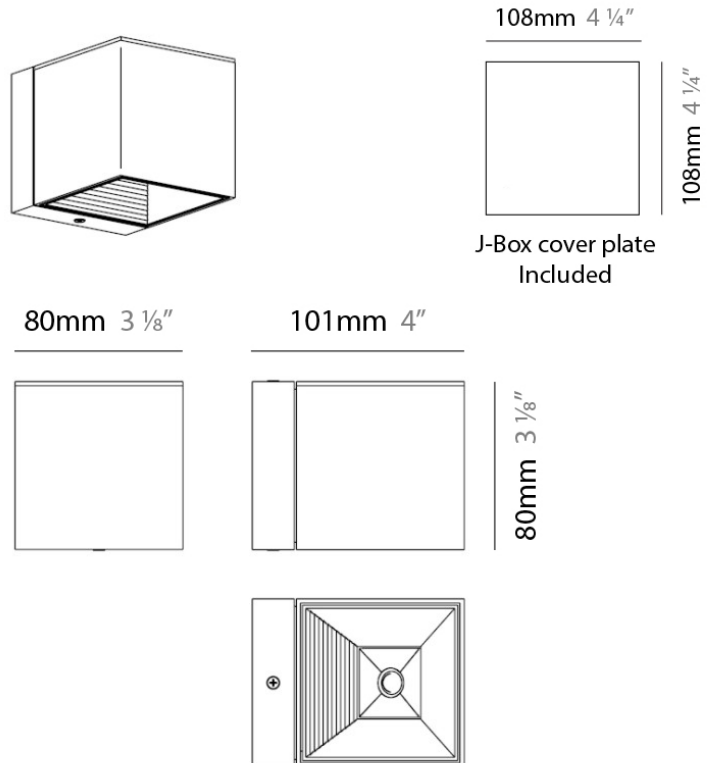

DAU SURFACE

D93148

| | |
|----------|--|
| PROJECT | |
| TYPE | |
| NOTES | |
| QUANTITY | |
| DATE | |

GENERAL

Series: Dau
 Brand: Milan
 Division: Design
 Mounting Type: Surface
 Mounting Location: Wall
 Subcategory: Up/Down Light

PHYSICAL

Shape: Cube
 Length (mm): 110
 Length (in): 4 ⁵/₁₆
 Height (mm): 110
 Height (in): 4 ⁵/₁₆
 Extension (mm): 101
 Extension (in): 4.0
 Weight (kg): 0.91
 Weight (lbs): 2
 Fixture Finish: SST
 Fixture Material: Metal

ELECTRICAL

Number of Lamps: 2
 Lamp Type: LED
 Total Output Wattage (W): 8
 Max. Wattage Per Lamp (W): 4
 Dimming: Electronic Low Voltage Dimming
 Driver Type: operates without a driver
 Input Voltage (V): 120

LED

Delivered Lumen Range: 100 - 499 lm
 Number of LEDs: 2
 Color Temperature (°K): 2700 / 2900
 Max. Delivered Lumen (lm): 339.01
 Nominal Lumen (lm): 600
 CRI: >80 CRI

OPTICAL

RATINGS AND CERTIFICATIONS

Certified By: CSA Certified to UL and CSA Standards
 IP rating: IP44

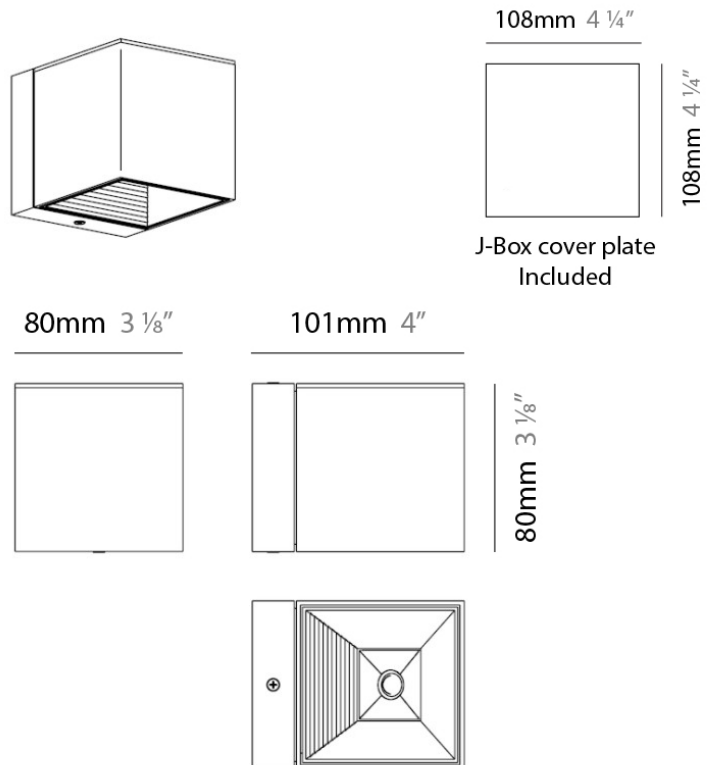

DAU SURFACE

D93153

| |
|----------|
| PROJECT |
| TYPE |
| NOTES |
| QUANTITY |
| DATE |

GENERAL

Series: Dau
 Brand: Milan
 Division: Design
 Mounting Type: Surface
 Mounting Location: Wall
 Subcategory: Up/Down Light

PHYSICAL

Length (mm): 110
 Length (in): 4 ⁵/₁₆
 Height (mm): 170
 Height (in): 6 ¹¹/₁₆
 Extension (mm): 101
 Extension (in): 4.0
 Weight (kg): 0.9
 Weight (lbs): 2

ELECTRICAL

Lamp Type: LED
 Total Output Wattage (W): 8
 Max. Wattage Per Lamp (W): 4
 Dimming: Electronic Low Voltage Dimming
 Input Voltage (V): 120

LED

Number of LEDs: 2
 Color Temperature (°K): 2700 / 2900
 Nominal Lumen (lm): 600
 CRI: >80 CRI
 Lamp Life (hrs): 50000

OPTICAL

RATINGS AND CERTIFICATIONS

Certified By: CSA Certified to UL and CSA Standards
 IP rating: IP44

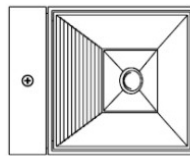

108mm 4 1/4"

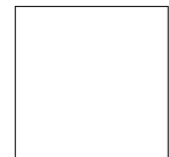

108mm 4 1/4"

J-Box cover plate
Included

80mm 3 1/8"

101mm 4"

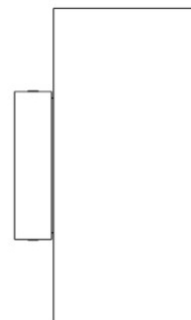

170mm 6 11/16"

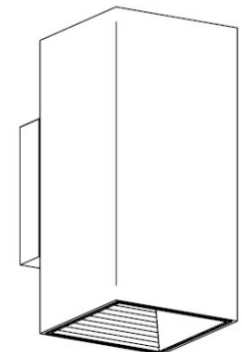

DAU SURFACE

D93189

| | |
|----------|--|
| PROJECT | |
| TYPE | |
| NOTES | |
| QUANTITY | |
| DATE | |

GENERAL

Series: Dau
 Brand: Milan
 Division: Design
 Mounting Type: Surface
 Mounting Location: Wall
 Subcategory: Up/Down Light

PHYSICAL

Shape: Cube
 Length (mm): 80
 Length (in): 3 1/8
 Height (mm): 101
 Height (in): 4
 Extension (mm): 114
 Extension (in): 4 5/16
 Light Distribution: Direct
 Weight (kg): 4.5
 Weight (lbs): 10

ELECTRICAL

Lamp Type: LED
 Max. Wattage Per Lamp (W): 10
 Dimming: Non-Dimmable
 Driver Included: Yes
 Driver Type: Constant Current
 Driver Class: Class 2
 Input Voltage (V): 120

LED

Delivered Lumen Range: 500 - 999 lm
 Number of LEDs: 1
 Color Temperature (°K): 2700
 Max. Delivered Lumen (lm): 829.93
 Nominal Lumen (lm): 1010
 CRI: >80 CRI

OPTICAL

Reflector°: 50° (available in 24° and 32° upon request)

RATINGS AND CERTIFICATIONS

Certified By: CSA Certified to UL and CSA Standards
 IP rating: IP44

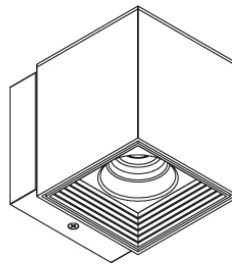

108mm 4 1/4"



108mm 4 1/4"

J-Box cover plate
Included

80mm 3 1/8"



101mm 4"

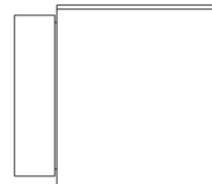

110mm 4 5/16"

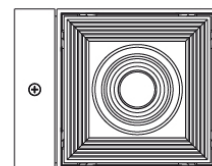

DAU SURFACE

D93197

| | |
|----------|--|
| PROJECT | |
| TYPE | |
| NOTES | |
| QUANTITY | |
| DATE | |

GENERAL

Series: Dau
 Brand: Milan
 Division: Design
 Mounting Type: Surface
 Mounting Location: Wall
 Subcategory: Up/Down Light

PHYSICAL

Shape: Rectangle
 Length (mm): 80
 Length (in): 3 1/8
 Height (mm): 200
 Height (in): 7 7/8
 Extension (mm): 101
 Extension (in): 4
 Light Distribution: Direct / Indirect
 Weight (kg): 4.5
 Weight (lbs): 10
 Fixture Finish: WHI
 Fixture Material: Metal

ELECTRICAL

Lamp Type: LED
 Total Output Wattage (W): 20
 Max. Wattage Per Lamp (W): 10
 Dimming: Electronic Low Voltage Dimming
 Driver Type: 120V DIRECT LINE (operates without a driver)
 Input Voltage (V): 120

LED

Number of LEDs: 2
 Color Temperature (°K): 2700
 Nominal Lumen (lm): 2 x 1010
 CRI: >80 CRI

OPTICAL

Reflector°: 50

RATINGS AND CERTIFICATIONS



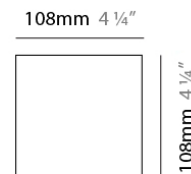
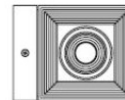
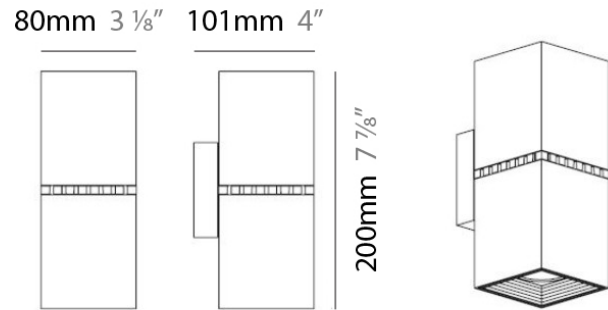

































































Certified By: CSA Certified to UL and CSA Standards
 IP rating: IP44



J-Box cover plate
Included



LEGEND

| | | | | | |
|--|---|---|--|---|--|
|  | floor-mounted |  | pivotal |  | special LED (upon request) RGB, RGBW, tunable, gold+, meat+, art+, fashion+ |
|  | wall and ceiling: recessed and surface mounted |  | rotating |  | warm dim / natural dimming LED |
|  | ceiling-mounted and wall-mounted |  | illuminate tilted |  | rechargeable battery powered |
|  | wall-mounted |  | color of suspension cable |  | fixture with natural vivid LED (upon request) |
|  | omni-directional light distribution |  | length of suspension cable |  | color rendering index |
|  | direct light distribution |  | reflector degree selection |  | color temperature |
|  | direct/indirect light distribution |  | super spot |  | lumen (luminous flux) |
|  | indirect light distribution |  | lens |  | efficacy (lumens per watt) |
|  | asymmetric light distribution |  | lens pack |  | Unified Glare Rating (UGR) range from 5-40 |
|  | aura light distribution |  | shine ring |  | marine grade (AISI 316 stainless steel) |
|  | round wall or ceiling cut-out |  | integrated shine ring with diffuser |  | walk on |
|  | square wall or ceiling cut-out |  | free individual colors 01-29 |  | drive on |
|  | the supplied jig specifies the cutout dimensions |  | individual colors: 00 (free of charge), 01-25 (extra charge) |  | Dark Sky Compliance |
|  | minimum distance (meters) lamp - object |  | luminaire part to be colored (F1) |  | Americans with Disabilities Act (less than 4" off the wall located between 27"-84" from floor) |
|  | recessed depth |  | luminaire part to be colored (F2) |  | lamp protected against explosion |
|  | ceiling thickness in mm |  | luminaire part to be colored (F3) |  | blown glass using traditional methods by master glass blower |
|  | ceiling thickness selection |  | luminaire part to be colored (F4) |  | acoustic material |
|  | dimmable DP (phase), DV (0-10V), DD (dali), DS (step-dim) |  | luminaire part to be colored (F5) |  | protection class I, protection insulation |
|  | included or excluded LED driver/transformer/control gear |  | color of 3-circuit adaptor |  | protection class II, protection insulation |
|  | separately switchable |  | indirect diffuser |  | ETL Certified to UL and CSA Standards |
|  | sensor |  | direct diffuser |  | UL Certified to UL and CSA Standards |
|  | remote control |  | ball-proof (upon request) |  | CSA Certified to UL and CSA Standards |
|  | available upon request |  | accessory |  | Certified for North American Standards |

IP RATING

| | |
|---|--|
|  | protected against ingress of solid bodies greater than 12.5mm (finger) |
|  | protected against ingress of solid bodies greater than 2.5mm protected against sprays of water up to 60 degrees from the vertical (rain) |
|  | protected against ingress of solid bodies greater than 1mm (wire) no protection against the ingress of moisture |
|  | protected against ingress of solid bodies greater than 1mm (wire) protected against sprays of water up to 60 degrees from the vertical (rain) |
|  | protected against ingress of solid bodies greater than 1mm (wire) protected against water splashed from all directions |
|  | protected against limited ingress of dust (wet rooms/covered outdoor areas) protected against water splashed from all directions |
|  | protected against ingress of dust protected against jets of water |
|  | protected against ingress of dust protected against powerful jets of water or heavy seas |
|  | protected against ingress of dust protected against immersion of water between 15cm - 1m for 30 minutes |
|  | protected against ingress of dust protected against immersion of water under pressure for long periods |

IK RATING

| | |
|---|---|
|  | protected against 0.14 joules impact (equivalent to 0.25kg mass dropped from 56mm above the surface) |
|  | protected against 0.2 joules impact (equivalent to 0.25kg mass dropped from 80mm above the surface) |
|  | protected against 0.35 joules impact (equivalent to 0.25kg mass dropped from 140mm above the surface) |
|  | protected against 0.5 joules impact (equivalent to 0.25kg mass dropped from 200mm above the surface) |
|  | protected against 0.7 joules impact (equivalent to 0.25kg mass dropped from 280mm above the surface) |
|  | protected against 1 joules impact (equivalent to 0.25kg mass dropped from 400mm above the surface) |
|  | protected against 2 joules impact (equivalent to 0.5kg mass dropped from 400mm above the surface) |
|  | protected against 5 joules impact (equivalent to 1.7kg mass dropped from 300mm above the surface) |
|  | protected against 10 joules impact (equivalent to 5.0kg mass dropped from 200mm above the surface) |
|  | protected against 20 joules impact (equivalent to 5.0kg mass dropped from 400mm above the surface) |